

scanomat

Radius Cabinets





Scanomat Radius Cabinet

Designed for Modern Spaces

The Radius Cabinet is crafted with a strong focus on quality, premium materials, and timeless design. Each cabinet is built from high-quality black MDF and finished with either real wood veneer or durable spray paint, creating a refined and tactile surface across both the tabletop and side panels.

Soft radius curves give the cabinet its signature look—elegant, welcoming, and perfectly suited to contemporary interiors.

How to Configure Your Cabinet

1 — Choose Your Base Cabinet

Select your preferred cabinet style and colour. This forms the foundation of your configuration.

2 — Choose Your Tabletop

Pick between standard, Coffee Glass System, or Double-deck tabletop, and select your preferred finish.

3 — Select Your iPad Option

Choose how the iPad should be mounted.

Remember to specify if you need cut-out for the iPad.

4 — Choose Your Legs

Decide between brass or stainless steel legs, and add mobility with wheels.

5 — Add Accessories



Radius Cabinets

1. Base Layout

The Base Layout provides the standard Radius Cabinet setup and serves as the starting point for all further customisation. When ordered in this version, the only choices you need to specify are your preferred iPad option and whether you require the tabletop cut-out.



Ebony Radius

Standard Configuration	
Tabletop	Ebony
Side Panels	Ebony
Legs	Brass
Dimensions (WxDxH)	133x45x90 cm
SKU	4000000



Wimborne White Radius

Standard Configuration	
Tabletop	Wimborne White
Side Panels	Wimborne White
Legs	Stainless Steel
Dimensions (WxDxH)	133x45x90 cm
SKU	4000000WH

Radius Cabinet

2. Tabletops



Ebony Tabletop

The default tabletop delivered with the ebony Radius Cabinet. Can be ordered for the Wimborne White Radius Cabinet.

SKU

3500003



Wimborne White Tabletop

A clean, bright variation of our standard tabletop, finished in Wimborne White. Can be ordered for the Ebony Radius Cabinet.

SKU

2800000WH



Coffee Glass System

Showcase Amokka® coffee beans with this display-ready solution. This configuration includes a specialised tabletop and two integrated Coffee Cylinder Systems.

SKU

3500015



Double-Deck Tabletop

A layered design that adds structure and additional display or storage functionality. This system includes a raised second level supported by a divider.

SKU

3500012



Thoughtful details define the Radius Cabinet. The soft leather door pull adds a subtle, tactile accent that complements the cabinet's rounded form. Each ebony surface is uniquely individual, with natural variations in the veneer creating a rich depth of colour and texture—making every cabinet truly one of a kind.



Radius Cabinet

3. iPad Options & Cut-Outs



iPad Dock

A minimalist, floating dock designed to hold the iPad securely. The dock evolves alongside the latest iPad models to ensure perfect compatibility.

Please specify on order if you want the cut-out for the iPad dock (no extra charge).



iPad Mini Prestine

Our new Prestine case is mounted on a smooth, in-house developed rotating mechanism, offering effortless interaction. Fits 6th generation iPad Mini.

Please specify on order if you want the cut-out for the Prestine case (no extra charge).



Tabletop Preparation Note

All tabletops for the Radius Cabinets are prepared with a pre-cut template on the underside. This allows you to easily create the required openings—either by routing the cut-out for the iPad Dock using a copy-router or by drilling the hole needed for the Prestine holder.

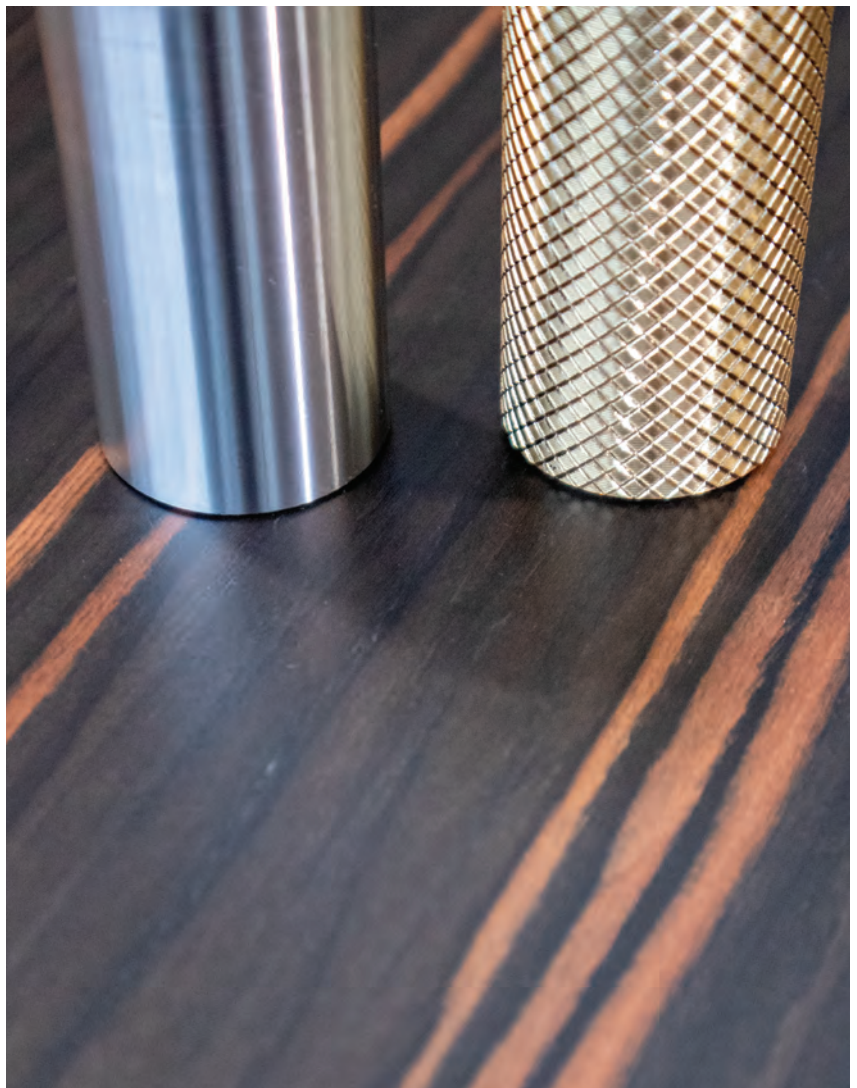
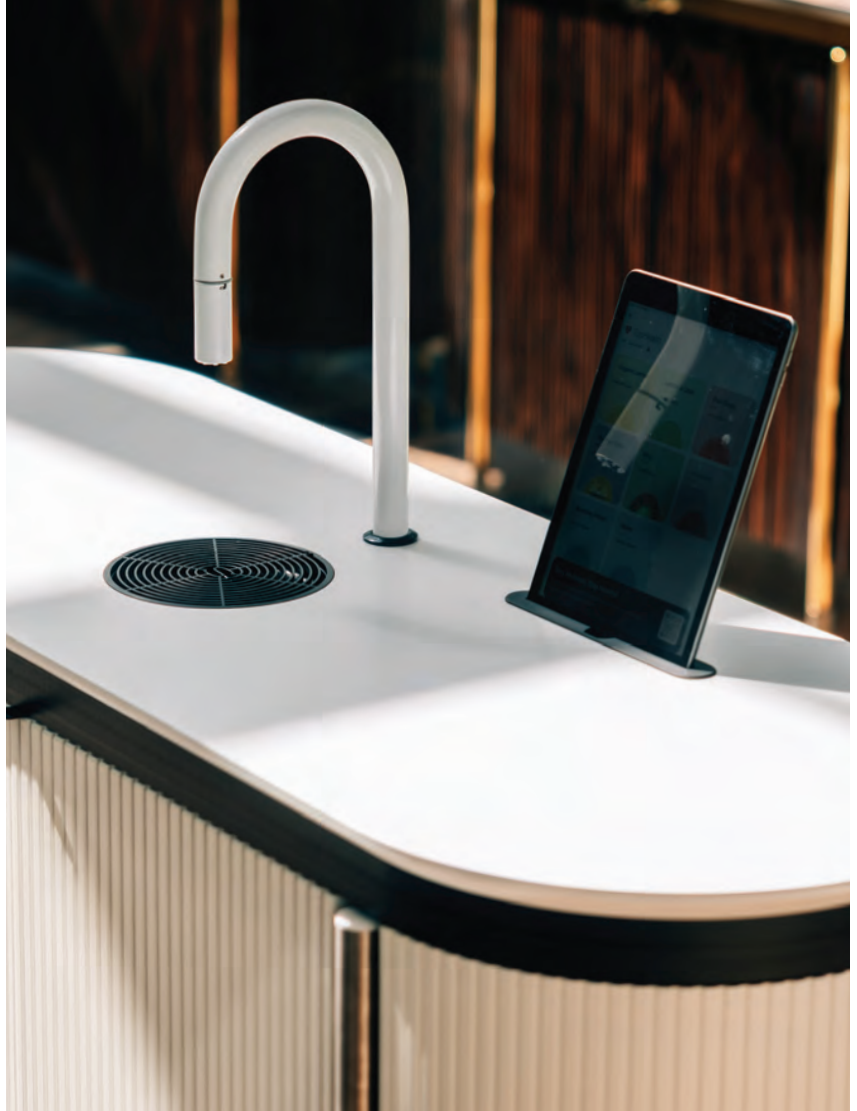

The Radius Cabinet brings together clean lines, premium materials, and thoughtful details. Available with legs in either knurled brass or brushed stainless steel, it allows you to tailor the expression to any interior. The flush-mounted drip tray grill sits level with the tabletop for a seamless, refined finish — enhancing both aesthetics and everyday usability.

Radius Cabinet

4. Leg Options



Brass Leg

Premium legs in brushed brass with knurled feet, offering a warm and elegant expression that complements both dark and light cabinet finishes.

SKU

3500006



Stainless Steel Leg

Durable stainless steel legs with solid stainless steel feet, giving the cabinet a clean, modern look and a highly resistant surface suitable for busy environments.

SKU

3500006SS



Wheels

Replace the standard feet with wheels to make the Radius Cabinet flexible and easy to move. Ideal for dynamic spaces or installations requiring mobility.

The wheels are mounted using the accompanying couplings, ensuring a stable and secure setup.

Black SKU

2012084

White SKU

2012089

Radius Cabinet

5. Accessories



Removable Water Tank

A removable 9-litre or 15-litre water tank that slides easily in and out and fits perfectly on top of the Smart Fridge. Designed for locations without a fixed water connection or for temporary setups.

SKU - 9L

3500060

SKU - 15L

3500060xl



Drain Drawer

The Drain Drawer adds practical mobility to the Radius Cabinet by integrating a built-in drain solution. It is ideal for installations where direct plumbing is not available or where additional flexibility is required.

SKU

3500059

Radius Cabinet Measurements

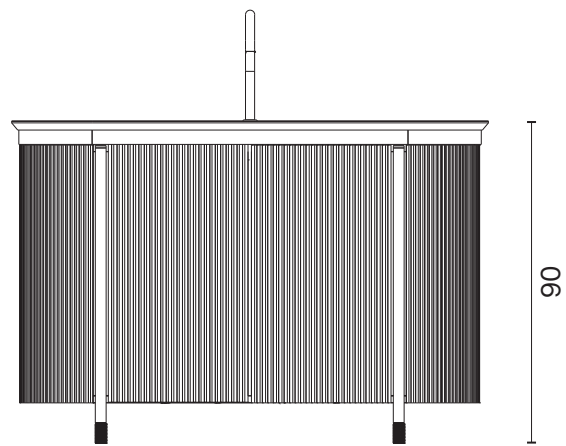
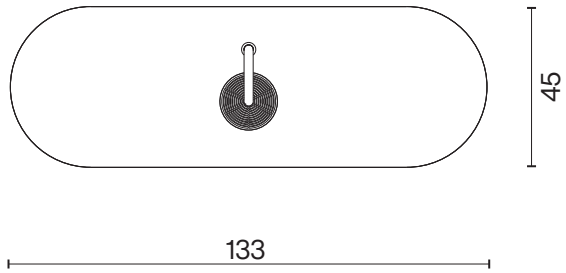

Base Layout

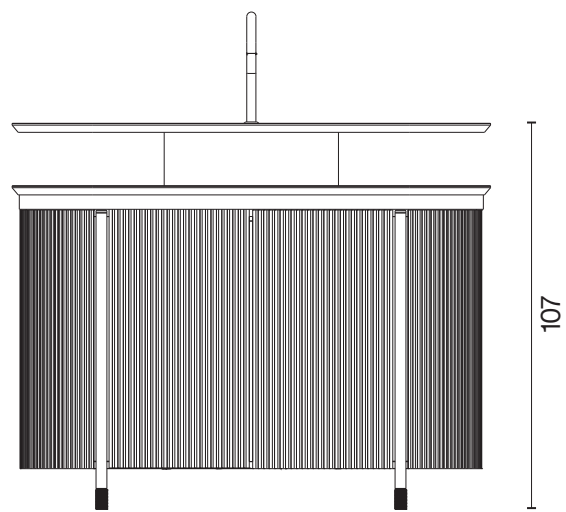
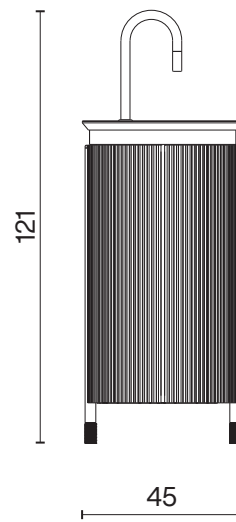

Double-Deck Tabletop

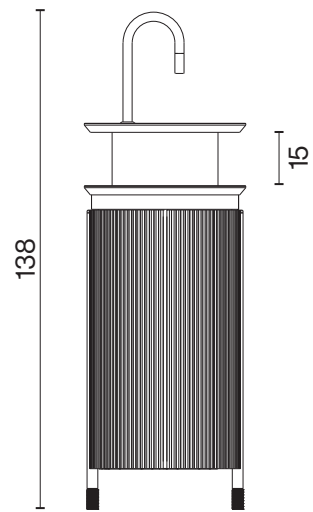

Radius Cabinet

Delivery and Assemble

Flat-Pack Delivery

The Radius Cabinet is delivered flat-packed in three manageable packages, making transport and on-site installation fast and simple. Every package is designed to keep the components protected while remaining easy to handle.

Package 1 – Tabletop & Frame Components
Includes the tabletop along with the cabinet's framing elements and legs.

Approx. size: 1370 x 490 x 155 mm

Package 2 – Side Panels

The straight side panels are delivered in their own protective flat pack.

Approx. size: 820 x 760 x 80 mm

Package 3 – Curved End Doors

The curved end doors come in a separate compact package that protects their rounded shape.

Approx. size: 720 x 330 x 200 mm



Assembly Made Easy

To help you get your Radius Cabinet ready quickly and correctly, we've created a short step-by-step video guide.

Simply click on or scan the QR code to follow the full assembly process. The video walks you through each stage—from unpacking the flat-pack components to completing the finished cabinet—making installation smooth, intuitive, and hassle-free.





scanomat

SCANOMAT.COM